

XL marlin Lighting

LED backlit Panel IP65 light (XL65PNO40B) Installation Instruction

The user: thank you for your purchase use this product, read this instruction manual before usage

1. Model: XL65PNO40B
2. Rated Voltage: 220-240 V 50/60 Hz
3. Rated Power: 40W
4. IP Grade: IP65
5. Operating Temperature: -20 to +40

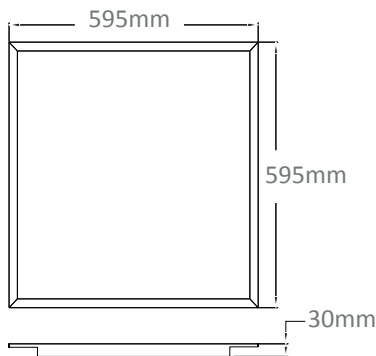

- Always disconnect the power supply before installing or performing any maintenance operations.
- Installation should be carried out by a suitably qualified person in accordance with good electrical practice and the appropriate national wiring regulations.
- These luminaires are widely used in commercial lighting, home decoration lighting, art gallery and museums.
- Only can be touched after 3 minutes later when power off, so as to avoid burns.
- Dismantling and refit are forbidden
- Installation on inflammables is forbidden.

If the external flexible cable or cord of this luminaire is damaged, it shall be exclusively replaced by the manufacturer or his service agent or a similar qualified person in order to avoid a hazard.

RECESSED GRID-CEILING

1. REMOVE THE CEILING GRID PANEL.

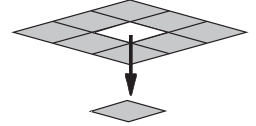

2. CONNECT THE LED DRIVER TO AC MAINS POWER.

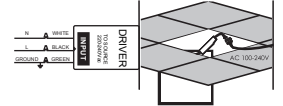

3. INSERT THE LED PANEL IN TO CEILING GRID

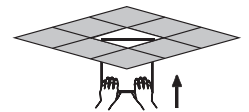

4. ROTATE THE PANEL TO INSERT EASILY IN TO THE CEILING GRID.

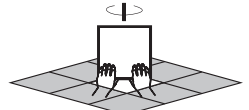

5. PLACE THE LED PANEL IN LINE WITH THE CEILING GRID.

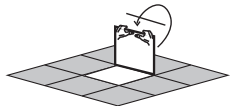

6. CONNECT THE POWER SUPPLY, LIGHT UP THE LAMP.

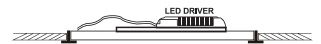

RECESSED SPRINGS

1. UNSCREW THE HIGHLIGHTED SCREWS FROM THE FOUR CORNERS OF THE PANEL

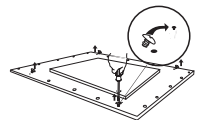

2. PLACE THE SPRINGS IN POSITION AND REINSTALL THE FOUR SCREWS. (THE SCREWS MUST BE INSERTED THROUGH THE CENTER HOLE OF THE CLIP AS ILLUSTRATED ABOVE).

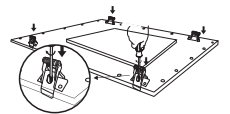

3. CUT A SQUARE HOLE IN THE CEILING 10MM SMALLER THAN THE LED PANEL.

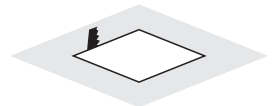

4. CONNECT THE LED DRIVER TO AC MAINS POWER. PUSH THE PANEL INTO THE CEILING CAVITY WITH THE SPRINGS RAISED.

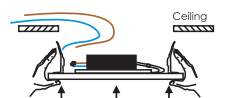

5. CONNECT THE POWER SUPPLY, LIGHT UP THE LAMP.



The light source of this luminaire is not replaceable; when the source reaches its end of life the whole luminaire shall be replaced

Welcome you again to buy our products